

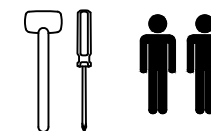

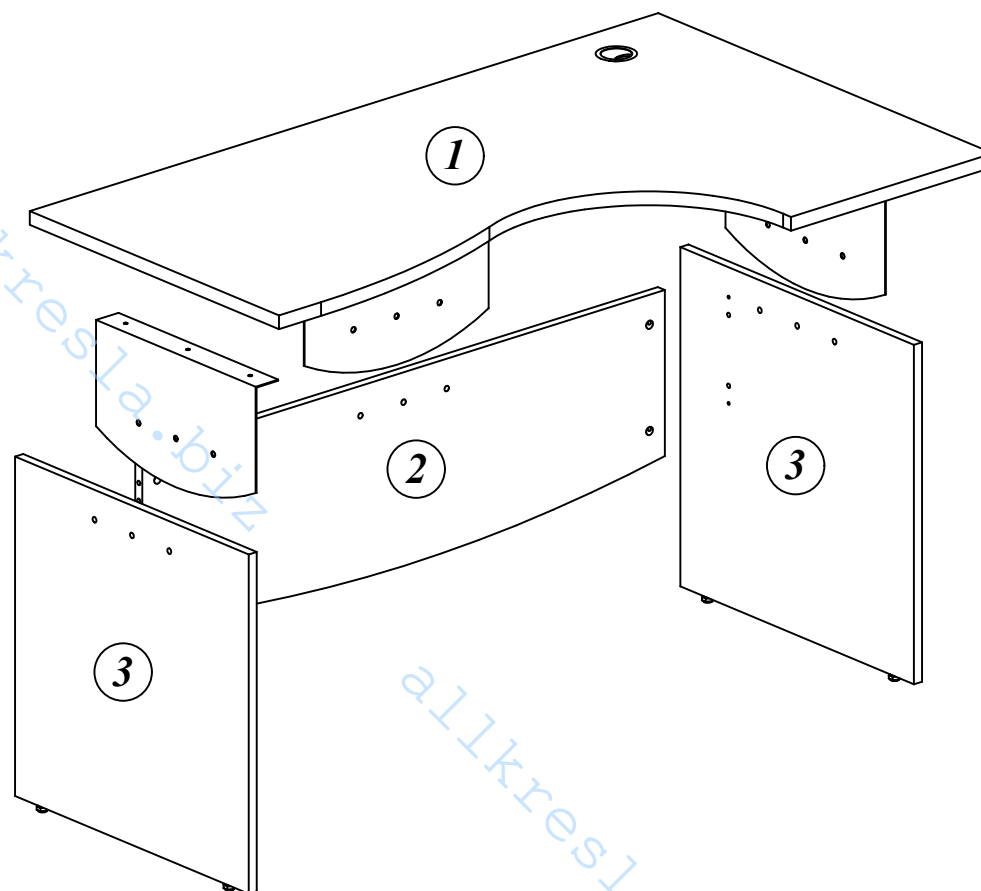













Схема сборки Стол письменный эргономичный OCET 149(L)(R), OCET 169(L)(R)



Комплектация деталей:

- 1. Столешница 1шт
- 2. Царга 1шт
- 3. Опора 2шт

Комплектация фурнитуры:

		 M6,3x16	9 шт.
	3 шт.		4 шт.
	4 шт.		4 шт.
	4 шт.		1 шт.
	9 шт.		4 шт.
	9 шт.		2 шт.
	4 шт.	 4x20	4 шт.
	1 шт.	 4x30	4 шт.

Габариты:
OCET 149(L)(R) 1400x860x750 мм
OCET 169(L)(R) 1600x860x750 мм

ВНИМАНИЕ!!!

Предприятие-изготовитель оставляет за собой право вносить изменения в конструкцию и применять фурнитуру, отличающуюся от указанной в схеме сборки, но не ведущие к ухудшению качества и кардинальному изменению внешнего вида изделия.

