

CT-2, CY-2 (ST-2, SU-2)

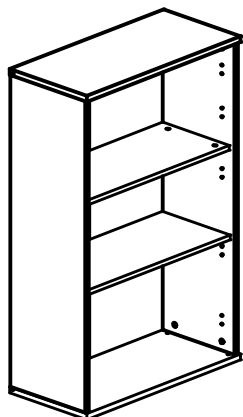

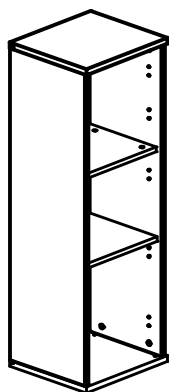





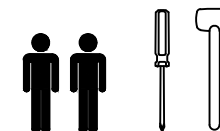
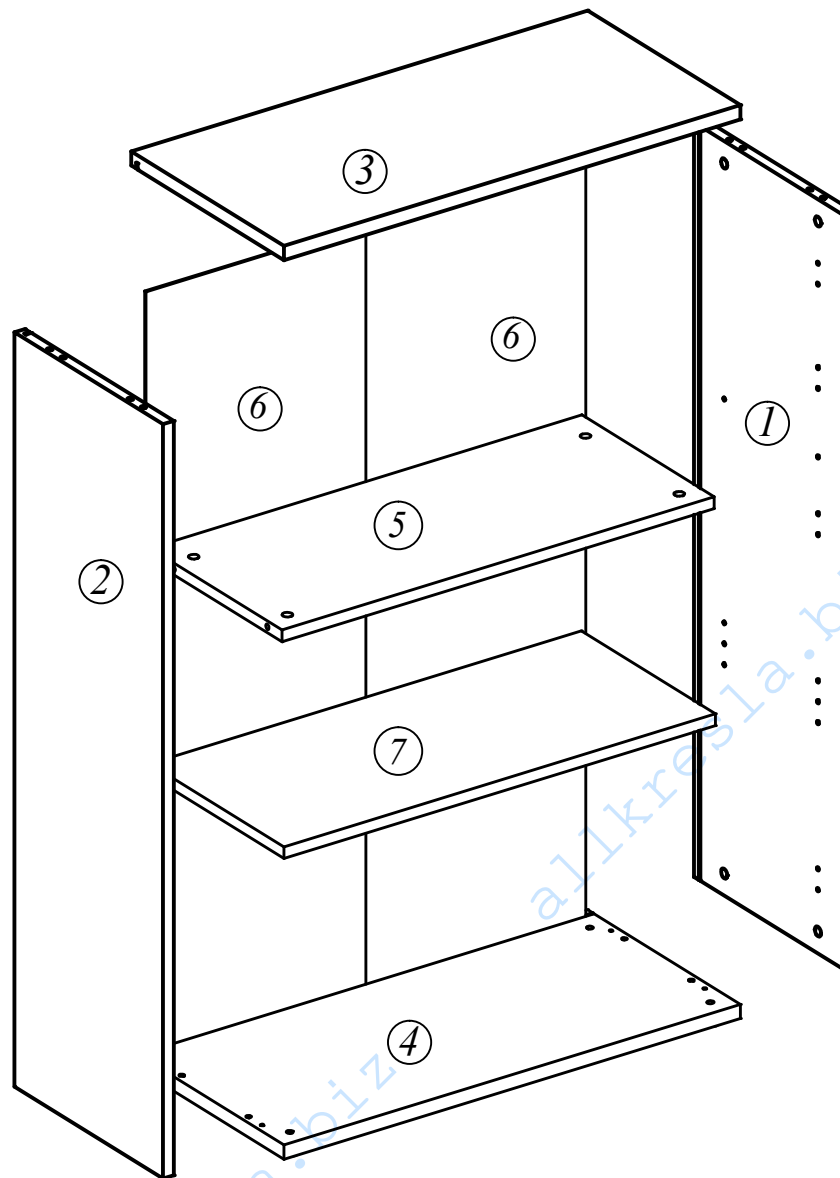

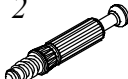
CT-2 (ST-2)

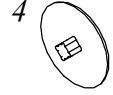

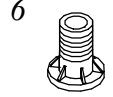
CY-2 (SU-2)



1	 x8	2	 x12
3	 x12	4	 x12
5	 x4	6	 x4
7	 x4	8	 5x16 x4
9	 x6 (CY-2) (SU-2)	9	 x8 (CT-2) (ST-2)

EAC

CT-2 (ST-2) - 770x365x1200

CY-2 (SU-2) - 406x365x1200

CT-2, CY-2 (ST-2, SU-2)

2

